

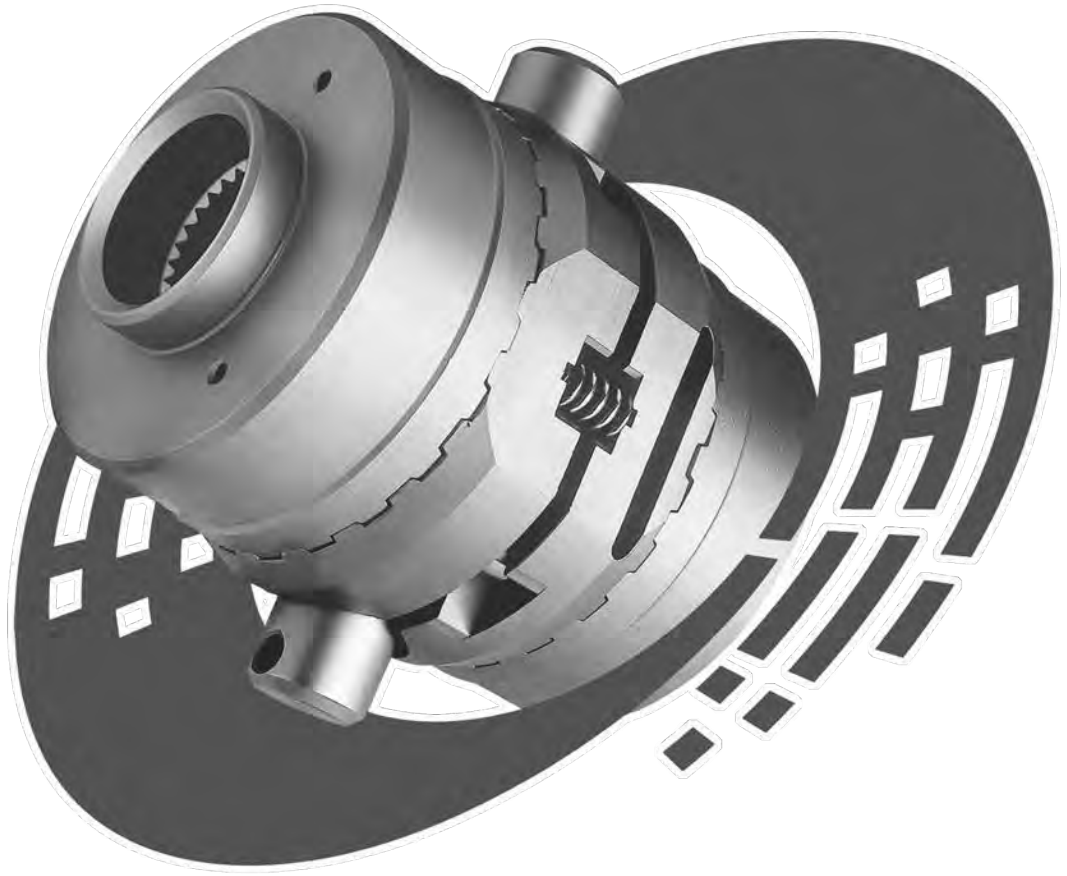

**NO-**  
**SLIP**  
*Traction System*™

**INSTALLATION GUIDE**

**8221011A**





# *Installation Guide*

<u>Contents</u>	<u>Page</u>
Open Differential Part Identification & Terminology.....	2
Powertrax No-Slip Differential Exploded View.....	3
Vehicle Preparation for Installation (steps 1 to 5).....	4
Removal of Open Differential Parts (steps 6 to 16).....	5
Preparation of Parts to be Installed (steps 17 to 19).....	9
Assembly (steps 20 to 36).....	10
Verification of Proper Assembly Test (steps 37 to 41).....	16
Finish Installation (steps 42 to 45).....	17

Thoroughly read User Manual.  
Traction output and resulting handling characteristics of your vehicle will be modified by installation.  
Drive carefully and use caution under all on-road and off-road conditions.

# OPEN DIFFERENTIAL

## PART IDENTIFICATION/TERMINOLOGY

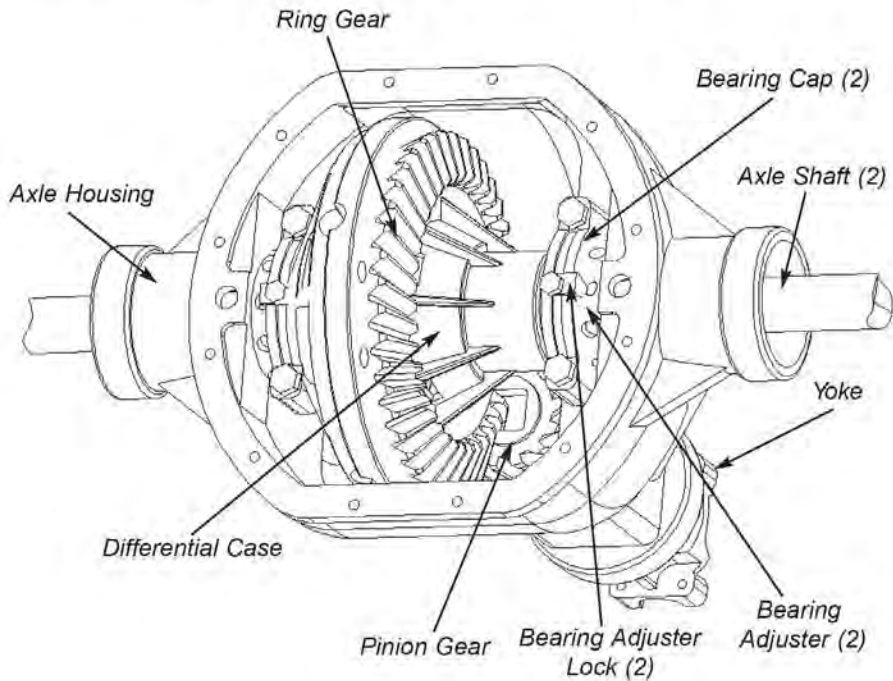

# EXPLODED VIEW

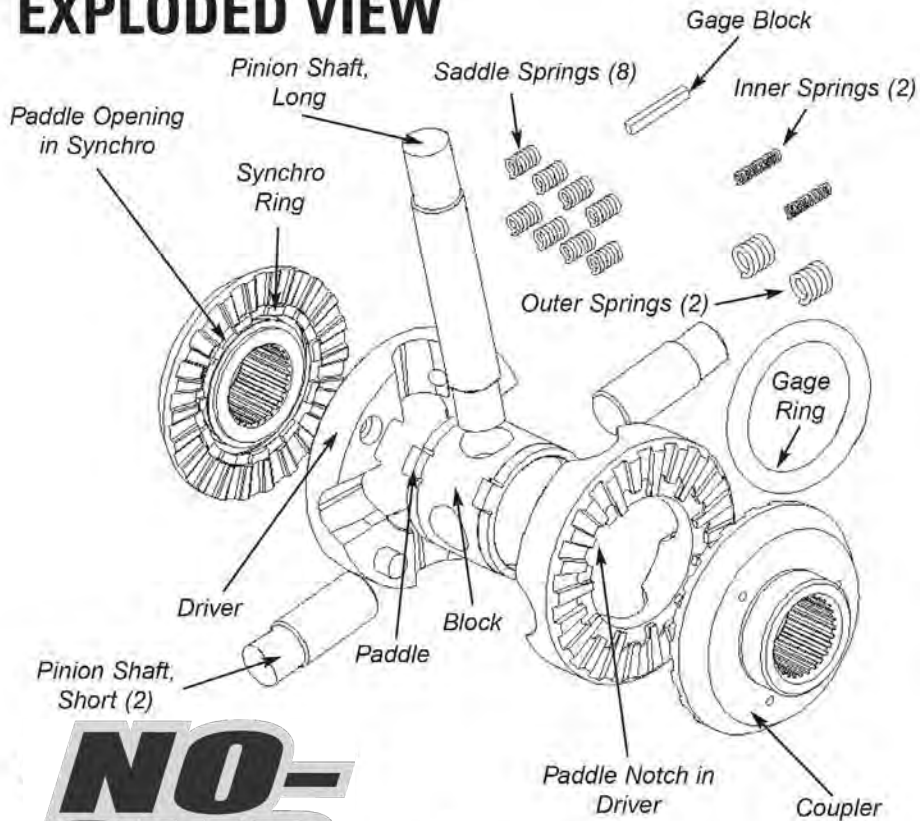



---

**1.** Put transmission in gear (or park), and turn off engine.



---

**2.** Set parking brake.



---

**3.** Safeguard the vehicle from rolling.



---

**4.** Safely raise vehicle and apply jack stands.

---

**5.** Put transmission in neutral and release parking brake.



6. Remove Differential cover and drain fluid. Clean the diff cover and housing sealing surface.

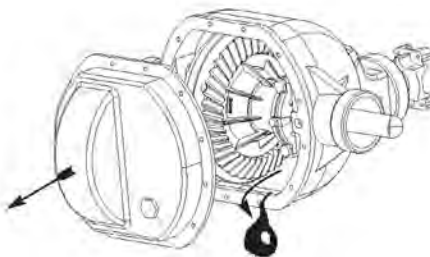

7. Remove axle shafts from housing.



8. Mark the position and orientation of the bearing caps to the housing and bearing adjusters to the adjuster locks. **These parts are not interchangeable and must be reinstalled in their original positions.**

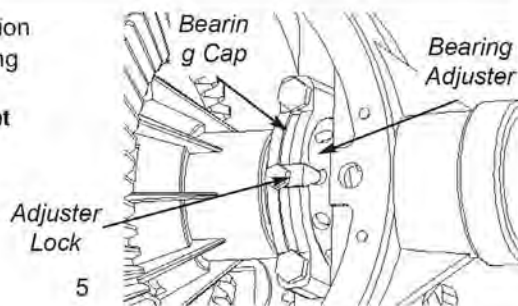

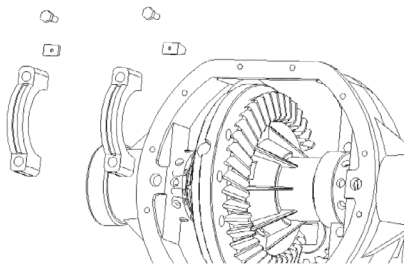

9. Remove adjuster locks and bearing caps from the housing. **These parts should have been marked in Step 8 as they are not interchangeable and must be reinstalled in their original positions.**

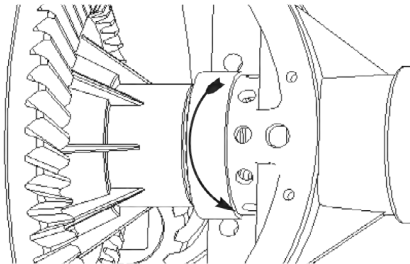

10. Loosen the bearing adjusters.

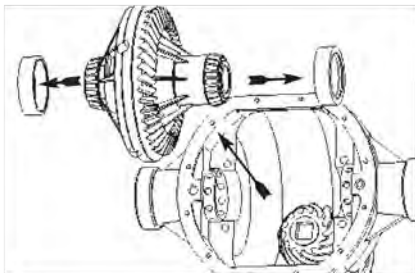

11. Pull out the differential case from the third member. Remove the bearing races from the bearings and mark them. **The bearing races must be installed on the same bearings they were originally on to avoid bearing failure.**



**12.** Mark the position of the ring gear to the two halves of the differential case and remove the ring gear. **The ring gear must be reinstalled in its original position.**

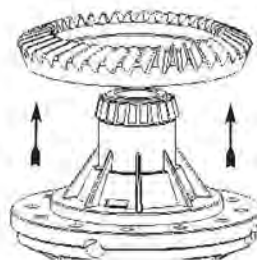

**13.** Remove the smaller half (cap) of the differential case. **The case halves should have been marked in Step 12 as they must be reinstalled in their original position.**

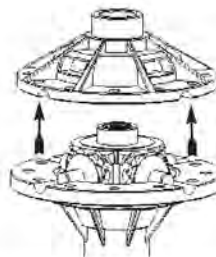

**14.** Remove the side gear and thrust washer.

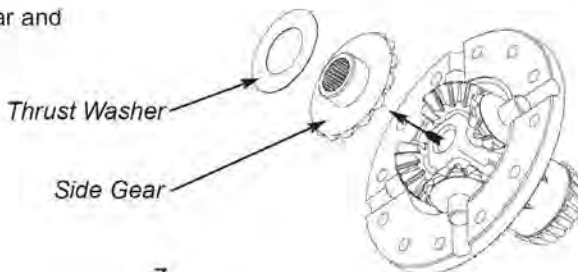

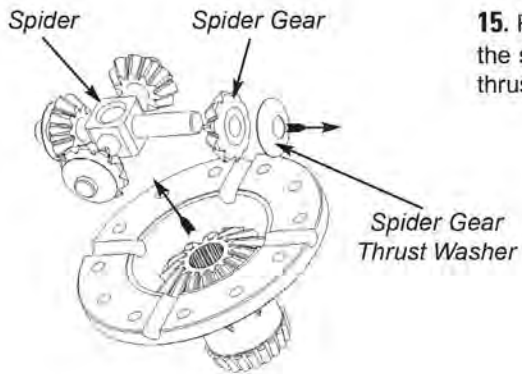

**15.** Remove the spider along with the spider gears and spider gear thrust washers from the case.



**16.** Remove the second side gear and thrust washer.

**17.** Verify gaps in coupler teeth are aligned with gaps in synchro ring. Place coupler in a vise and use the pinion shaft block to align them if necessary.



**18.** Apply wheel bearing grease to driver teeth.



**19.** Apply wheel bearing grease to saddle springs and seat in holes.



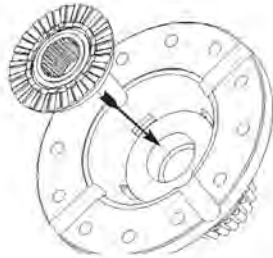

**20.** Install a coupler into the case.

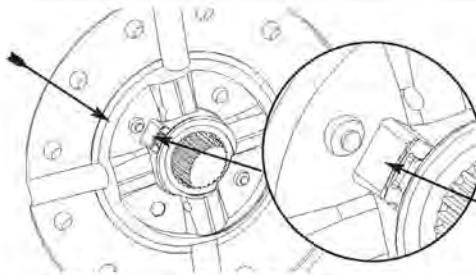

**21.** Insert the driver onto the coupler making sure the driver's notch is aligned with the paddle opening (widest gap) in the synchro ring. **The driver and coupler teeth should be fully engaged.**

*Driver Notch*

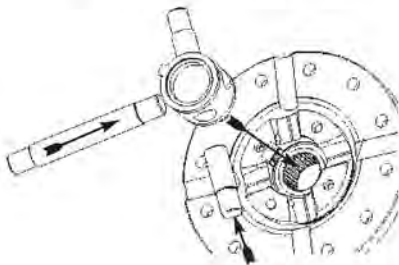

**22.** Insert the pinion shafts into the block (small diameters facing outwards) and insert the block with the pinion shafts into the case. Make sure the block's paddle passes through the driver notch and seats in the paddle opening (widest gap) in the synchro ring.

**23.** In order to check the clearance inside the differential case, temporarily set the second coupler onto the block, and place the gage ring and cap onto the coupler as shown. There should be a gap between the two halves of the differential case.

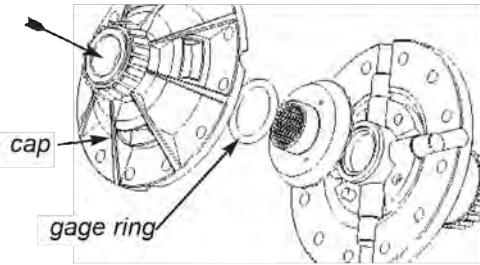

**24.** Check the gap in the differential case using the gage block. The narrow side of the block should fit in the gap, but the wider side should not fit.

*If gap is incorrect, STOP and call Powertrax Technical Support at 864-843-9275. There may be a problem with your differential case.*

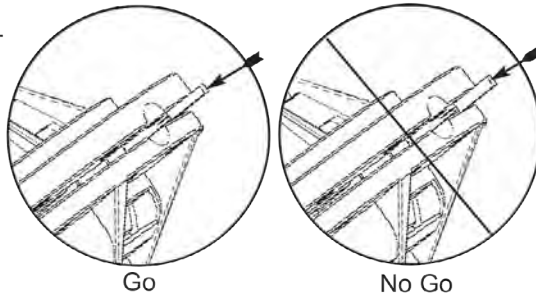

**25.** If the gap is correct, remove the cap, gage ring, and coupler to proceed.

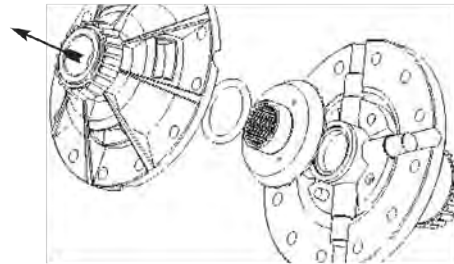



**26.** Place the two inner springs inside the two outer springs.

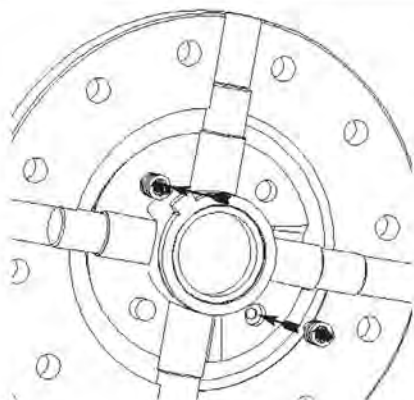

**27.** Place the two spring assemblies into the spring holes (holes with a step) in the driver.

**28.** Install the second driver into the differential case making sure the notch in the driver is aligned with the block's paddle.

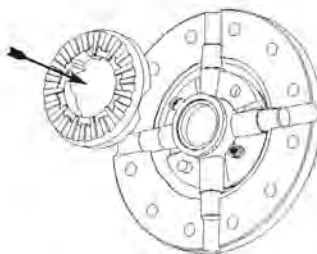

**29.** Install the second coupler into the differential case. **Make sure paddle opening (widest gap) in synchro ring is aligned with the block's paddle.**

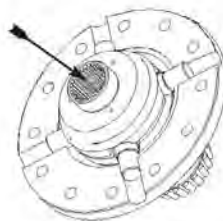

**30.** Install the cap onto the differential case. **Make sure the two case halves line up to their original positions.**

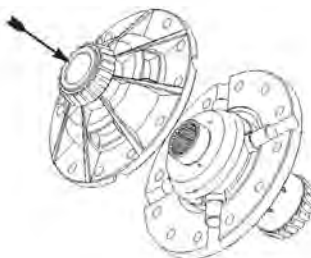

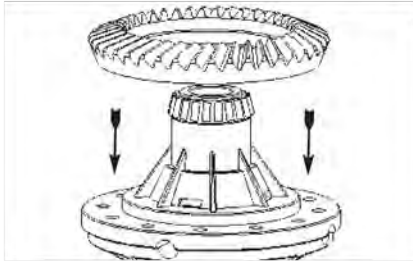

**31.** Install the ring gear back onto the case. **Make sure the mark on the ring gear lines up with the mark on the two halves of the case.**

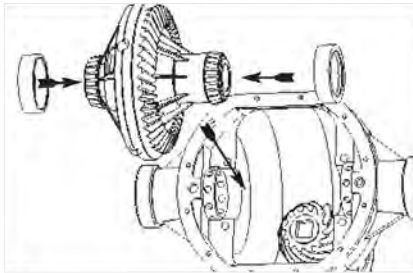

**32.** Place the bearing races on the corresponding bearings and install the assembly in the third member.

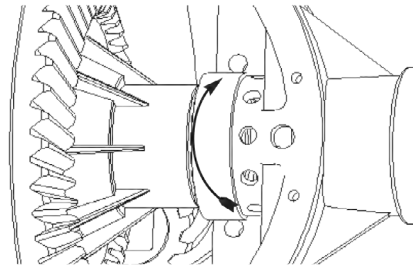

**33.** Tighten bearing adjusters back to their original positions.



**34.** Reinstall the bearing caps in **their original positions**. Tighten bearing caps down to required torque and reinstall bearing adjuster locks.

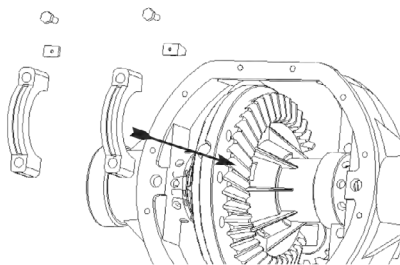

**35.** Reinstall axle shafts in housing.



**36.** Reinstall differential cover.

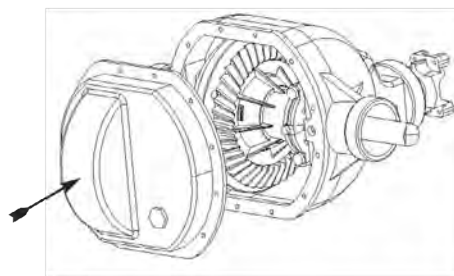



**37.** Put transmission in gear (or park).



**38.** Turn driver's side wheel forward and hold against driveline for steps 39 & 40.

**39.** Passenger side wheel should not be able to rotate in the same direction.

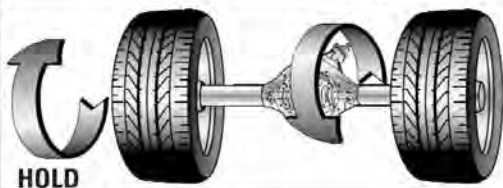
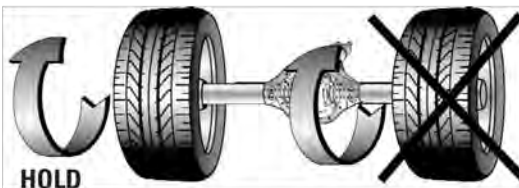

**40.** After sharply turning the passenger side wheel in the opposite direction (to disengage the unit), the wheel should rotate freely.

**41.** Repeat the test for both wheels in both directions.

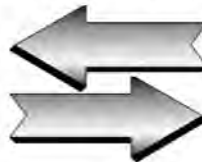



---

**42.** Add Richmond Synthetic Gear Oil (75W-140) available at your Authorized Richmond Distributor.



---

**43.** Set parking brake.



---

**44.** Be sure transmission is in gear or park.

---

**45.** Remove jack stands, lower vehicle, then remove blocks.

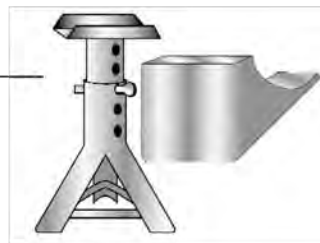



## IMPORTANT INFORMATION



**Please Read Carefully**



*The following  **WARNING** and  **CAUTION** information is supplied to you for your protection and to provide you with many years of trouble free and safe operation of your Richmond Gear product.*

Read **ALL** instructions prior to operating transmission and/or ring and pinion. Injury to personnel, transmission or ring and pinion failure may be caused by improper installation, maintenance or operation.



- **It is dangerous to get under a jacked-up vehicle.** The vehicle could slip off the jack and fall on you. You could be crushed. Never place any part of your body under a vehicle that is on a jack. Never start or run the engine while the vehicle is on a jack. **If you need to get under a raised vehicle, take it to a service center where it can be raised on a lift.**



- Hot oil can cause severe burns. Use extreme care when removing lubrication plugs and when working close to a unit that has been in operation.
- Check lube level between scheduled lube changes to insure that proper lube level is maintained. Inspect vent plug to insure it is clean and operating. Inspect the tightness of mounting bolts, misalignment of connecting shafts, lube leakage, excessive heating, or any unusual noise or vibration.
- Serious personal injury may occur as a result of improperly performed maintenance, adjustments or repairs.
- Do not attempt any of the maintenance, checks or repairs described on the following pages if you are not fully familiar with these or other procedures with respect to the transmission, or are uncertain as to how to proceed. Have the necessary work done by a properly equipped and qualified workshop.
- Always be extremely careful when working on the transmission. Always follow commonly accepted safety practices and general common sense. Never risk personal injury.



- Do not operate the transmission or ring and pinion without proper lube and correct amount.

- For safe operation and to maintain the unit warranty, when changing a factory installed fastener for any reason, it becomes the responsibility of the person making the change to properly account for fastener grade, thread engagement, load, tightening torque and the means of torque retention.
- Mounting bolts should be periodically checked to ensure that the unit is firmly anchored for proper operation.
- These instructions are not intended to cover all details or variations in equipment, nor provide for every possible contingency to be met in connection with selection, installation, operation, and maintenance. Should further information be desired or should particular problems arise which are not covered sufficiently for the Buyer's purpose, the matter should be referred to Richmond Gear.

In the event of the resale of any of the goods, in whatever form, Resellers/Buyers will include the following language in a conspicuous place and in a conspicuous manner in a written agreement covering such sale:

The manufacturer makes no warranties or representations, express or implied, by operation of law or otherwise, as to the merchantability or fitness for a particular purpose of the goods sold hereunder. Buyer acknowledges that it alone has determined that the goods purchased hereunder will suitably meet the requirements of their intended use. In no event will the manufacturer be liable for consequential, incidental or other damages. Even if the repair or replacement remedy shall be deemed to have failed of its essential purpose under Section 2-719 of the Uniform Commercial Code, the manufacturer shall have no liability to Buyer for consequential damages.

Resellers/Buyers agree to also include this entire document including the danger, warnings and cautions above in a conspicuous place and in a conspicuous manner in writing to instruct users on the safe usage of the product.



Notes:

---

---

---

---

---

---

---

---

---

---

---

---

---

---

---

8221011A

**POWERTRAX<sup>®</sup>**

Chicago, Il.