

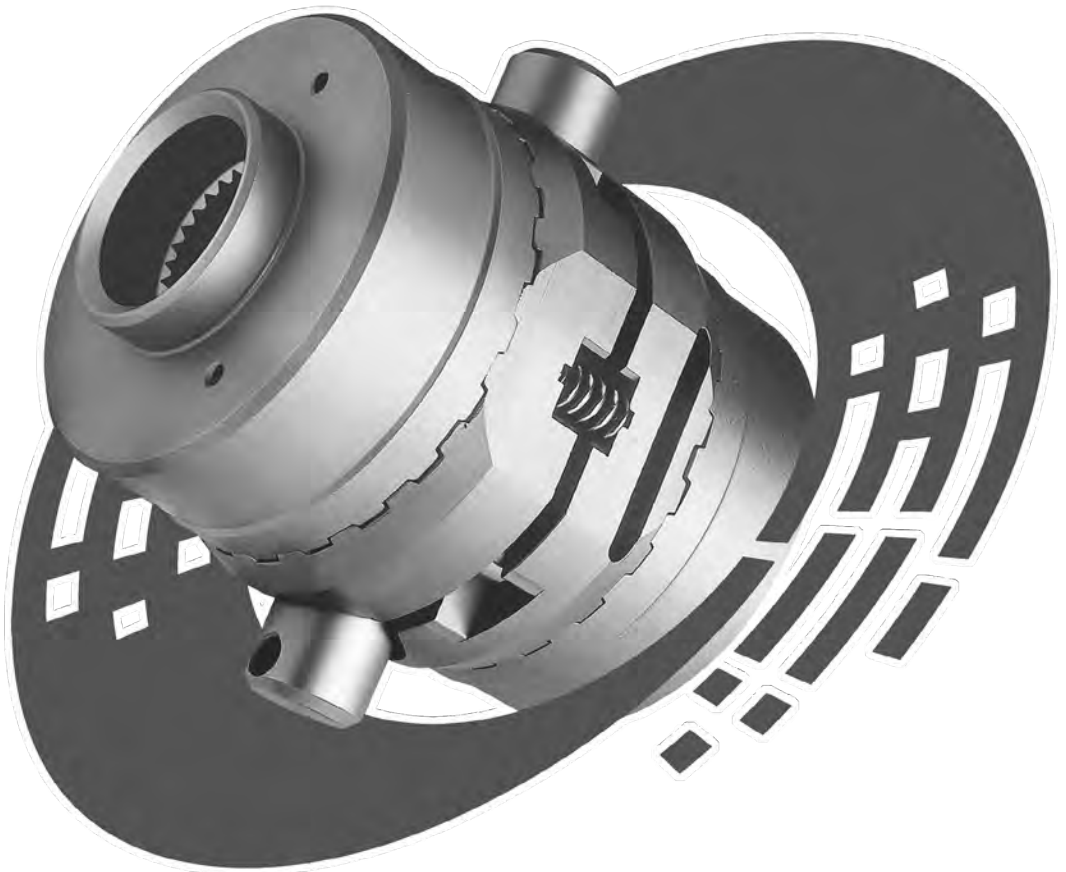

NO-
SLIP
Traction System™

INSTALLATION GUIDE

8221022A



WWW.POWERTRAX.COM



Installation Guide

<u>Contents</u>	<u>Page</u>
Open Differential Part Identification & Terminology.....	2
Powertrax No-Slip Differential Exploded View.....	3
Vehicle Preparation for Installation (steps 1 to 5).....	4
Removal of Open Differential Parts (steps 6 to 11).....	5
Preparation of Parts to be Installed (steps 12 to 14).....	7
Assembly (steps 15 to 37).....	8
Verification of Proper Assembly Test (steps 38 to 42).....	16
Finish Installation (steps 43 to 47).....	17

Thoroughly read User Manual.

Traction output and resulting handling characteristics of your vehicle will be modified by installation.

Drive carefully and use caution under all on-road and off-road conditions.

OPEN DIFFERENTIAL

PART IDENTIFICATION/TERMINOLOGY

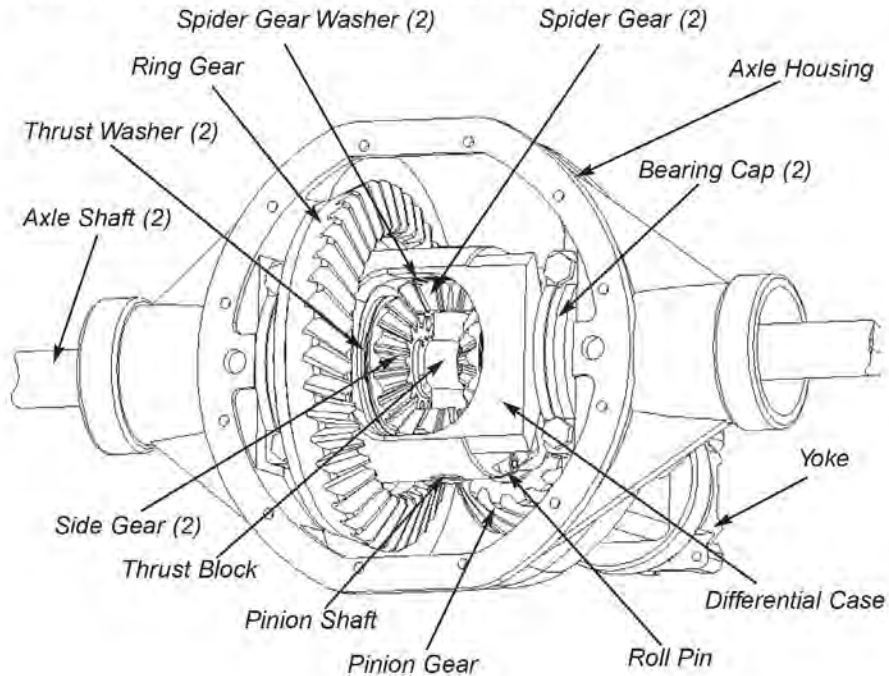

EXPLODED VIEW

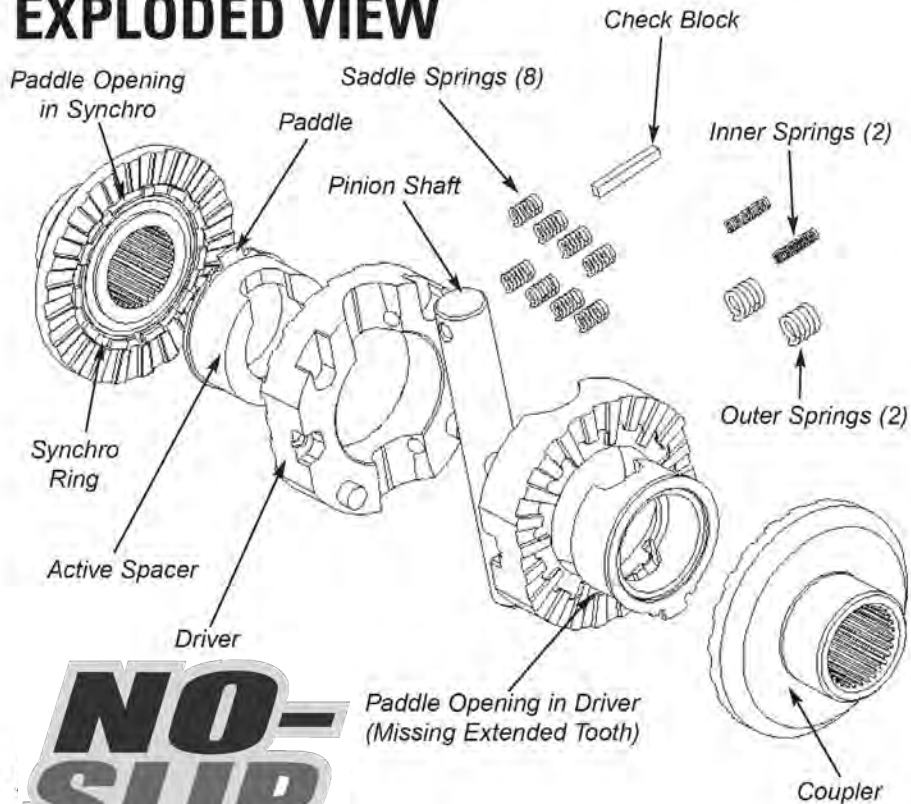

**NO-
SLIP**
Traction System™



1. Put transmission in gear (or park), and turn off engine.



2. Set parking brake.



3. Safeguard the vehicle from rolling.



4. Safely raise vehicle and apply jack stands.

5. Put transmission in neutral and release parking brake.



6. Remove Differential cover and drain fluid. Clean the diff cover and housing sealing surface.

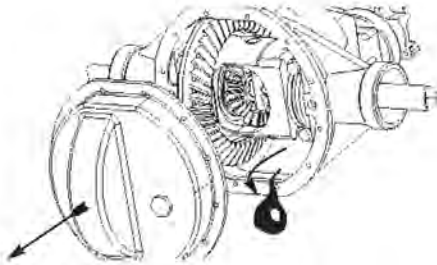

7. Expose pinion shaft; use a punch to drive out roll pin. Remove pinion shaft.

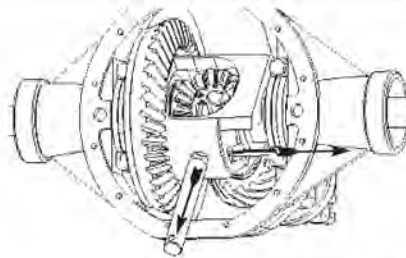

8. Remove the axle retaining bolts for the passenger side axle shaft located on the inside of the brake backing plate. Pull out passenger side axle shaft 2"-3". Slide thrust block to the right into the side gear.

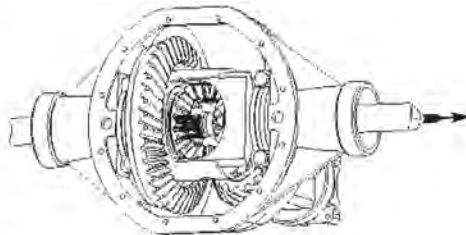

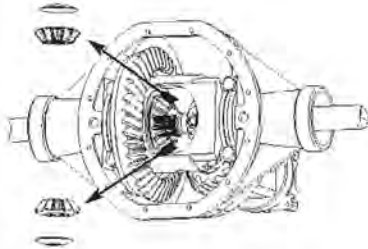

9. Remove both spider gears and their thrust washers.

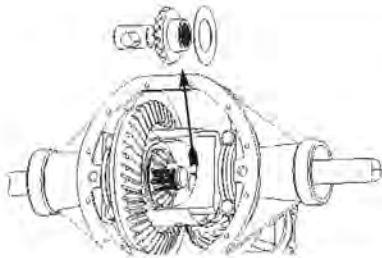

10. Remove passenger-side side gear/thrust block/thrust washer together. Retain thrust block.

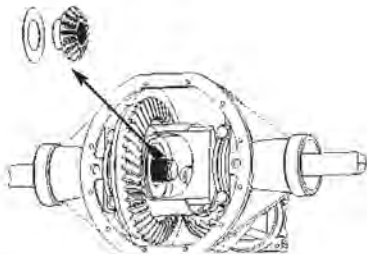

11. Remove remaining side gear and thrust washer.

12. Verify gaps in coupler teeth are aligned with gaps in synchro ring. Place coupler in a vise and use an active spacer to align them if necessary.

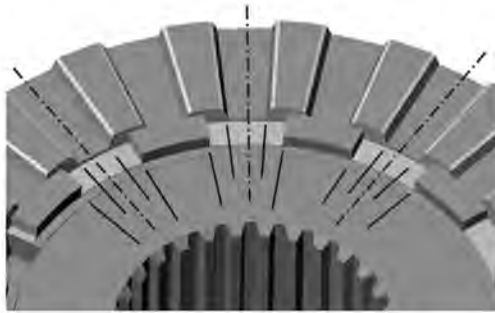

13. Apply wheel bearing grease to driver teeth and spacer.



14. Apply wheel bearing grease to saddle springs and seat in holes.



15. Insert the thrust block into the coupler that will go on the axle shaft opposite the ring gear.

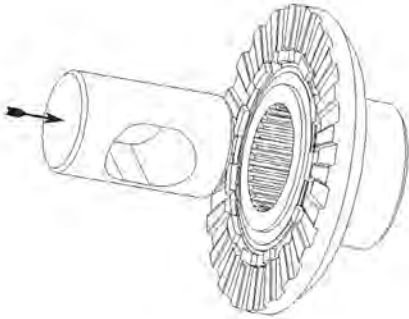

16. Insert the coupler into the ring gear side of the case first. Insert the coupler with thrust block into the side opposite the ring gear.

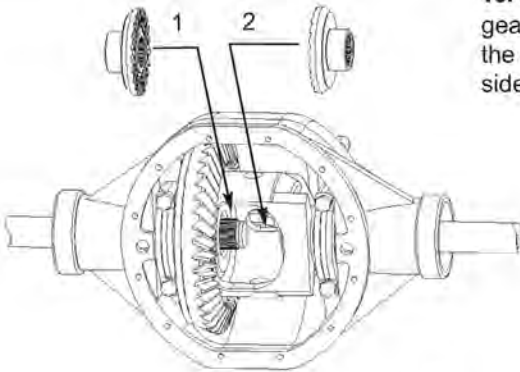

17. Make sure paddle opening (widest gap) in ring gear side synchro ring is facing out towards you.

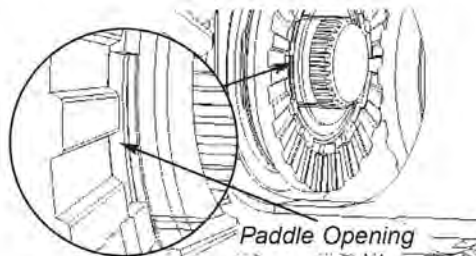

18. Insert an active spacer into a driver. Seat the spacer paddle at the paddle opening in driver (missing extended tooth).

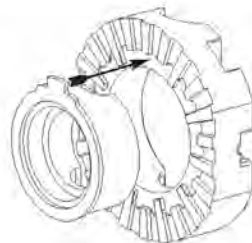

19. Insert driver/spacer as shown, making sure the spacer paddle is facing out towards you.

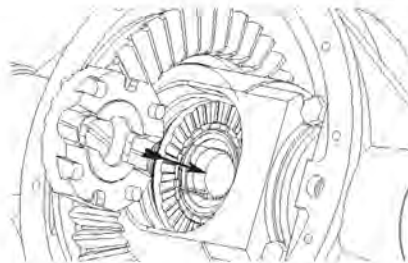

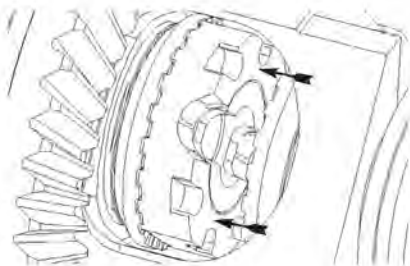

20. Verify spacer paddle is aligned with paddle opening in synchro ring and press driver/spacer down onto coupler. Driver teeth should be fully engaged all the way around.

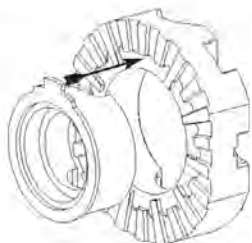

21. Insert the second active spacer into the second driver. Seat the spacer paddle at the paddle opening in driver (missing extended tooth).

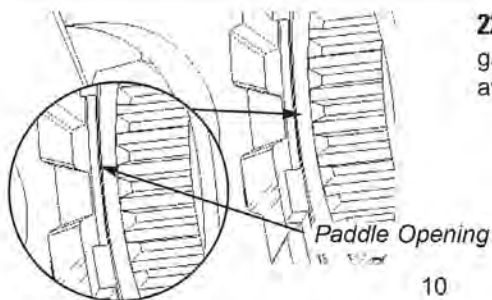

22. Verify paddle opening (widest gap) in other synchro ring is facing away from you.

23. Install second driver/spacer making sure the spacer paddle is pointing away from you.

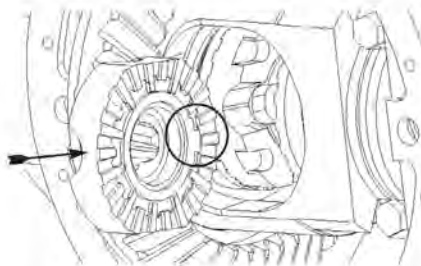

24. Verify spacer paddle is aligned with the paddle opening in synchro ring and press down on driver/spacer to seat on coupler; driver teeth should be fully engaged all the way around.

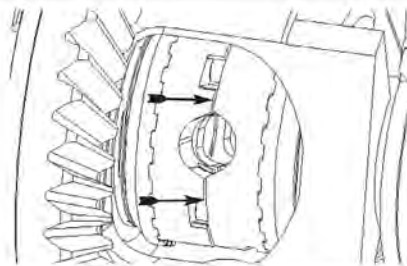

25. Wedge both drivers in engagement with couplers. Rotate driver's side wheel forward 1/4 turn to reveal spring slot.

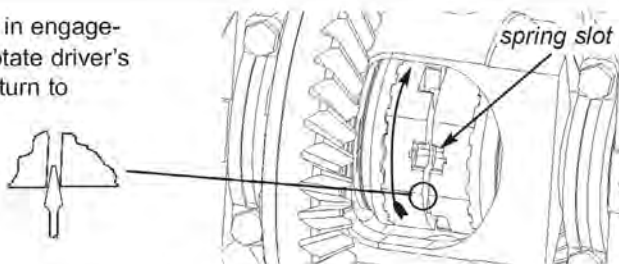



26. Place the two inner springs inside the two outer springs.

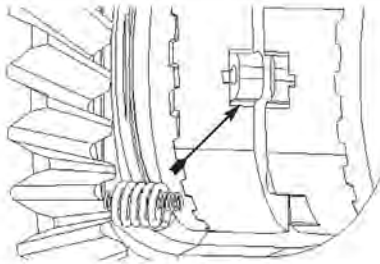

27. Compress inner spring and install spring assembly into spring slot.

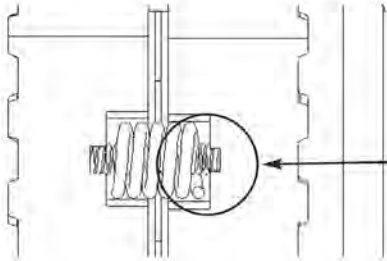

28. Visually inspect notches in spring slot to make sure inner spring is fully seated.

29. Keeping both drivers wedged in engagement with couplers, rotate driver's side wheel forward 1/2 turn to reveal spring slot on other side.

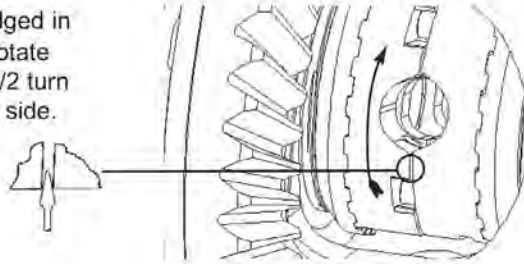

30. Compress inner spring and install the second spring assembly into the second spring slot.

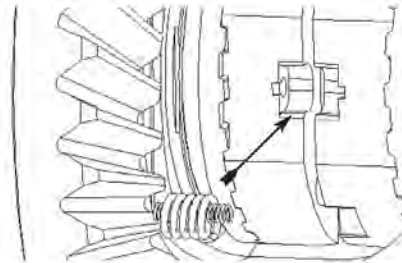

31. Visually inspect notches in spring slot to make sure inner spring is fully seated.

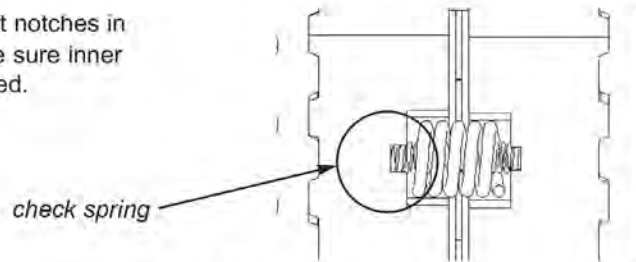

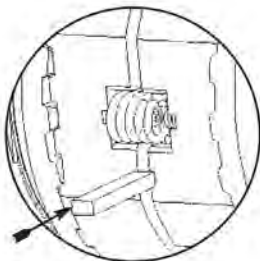

Go

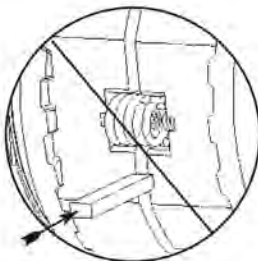

No-Go

32. Check the gap between drivers using check block. The narrow side of the block should fit between drivers, but the wider side should not fit.

If gap is incorrect, STOP and call Powertrax Technical Support at 864-843-9275. There may be a problem with your differential case.

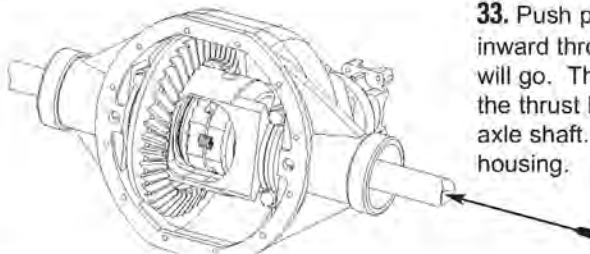

33. Push passenger side axle shaft inward through coupler as far as it will go. The axle shaft should push the thrust block against the opposite axle shaft. Bolt axle shaft back to housing.

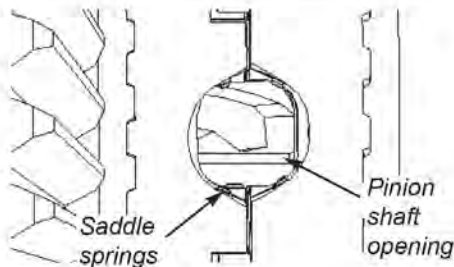

34. Keeping both drivers fully engaged, rotate both wheels back 1/4 turn to expose pinion shaft opening. Make sure saddle springs are all fully seated and the pinion shaft opening in the thrust block is aligned with the pinion shaft opening in the drivers.

35. Keeping couplers and drivers stationary, rotate case 1/4 turn forward to align pinion shaft openings.

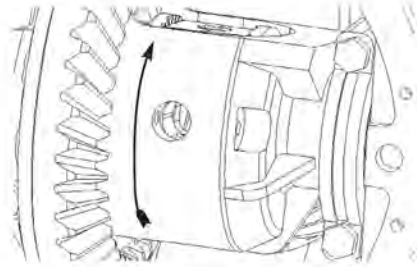

36. Using the roll-pin as a handle, insert the shaft into the differential. Press hard while twisting to pass shaft by springs.

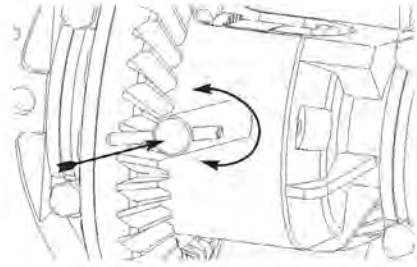

37. Drive roll-pin into case/shaft.

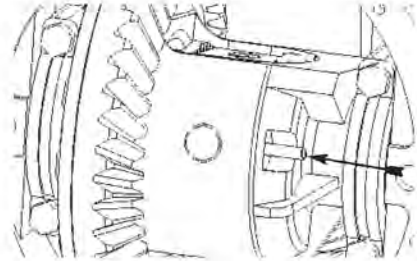



38. Put transmission in gear (or park).



39. Turn driver's side wheel forward and hold against driveline for steps 40 & 41.

40. Passenger side wheel should not be able to rotate in the same direction.

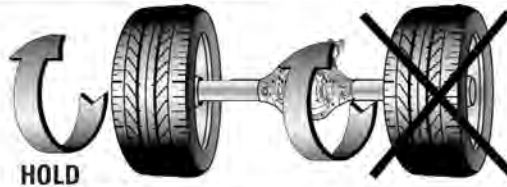

41. After sharply turning the passenger side wheel in the opposite direction (to disengage the unit), the wheel should rotate freely.

42. Repeat the test for both wheels in both directions.

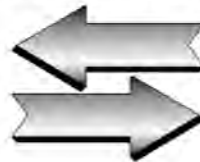



43. Install differential cover with gasket sealant.



44. Add Richmond Synthetic Gear Oil (75W-140) available at your Authorized Richmond Distributor.



45. Set parking brake.



46. Be sure transmission is in gear or park.

47. Remove jack stands, lower vehicle, then remove blocks.

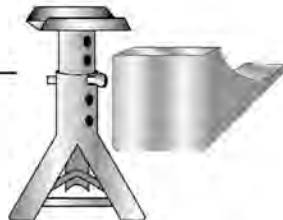

IMPORTANT INFORMATION

⚠ WARNING Please Read Carefully **⚠ CAUTION**

*The following **⚠ WARNING** and **⚠ CAUTION** information is supplied to you for your protection and to provide you with many years of trouble free and safe operation of your Richmond Gear product.*

Read **ALL** instructions prior to operating transmission and/or ring and pinion. Injury to personnel, transmission or ring and pinion failure may be caused by improper installation, maintenance or operation.

⚠ DANGER • **It is dangerous to get under a jacked-up vehicle.** The vehicle could slip off the jack and fall on you. You could be crushed. Never place any part of your body under a vehicle that is on a jack. Never start or run the engine while the vehicle is on a jack. **If you need to get under a raised vehicle, take it to a service center where it can be raised on a lift.**

⚠ WARNING • Hot oil can cause severe burns. Use extreme care when removing lubrication plugs and when working close to a unit that has been in operation.

- Check lube level between scheduled lube changes to insure that proper lube level is maintained. Inspect vent plug to insure it is clean and operating. Inspect the tightness of mounting bolts, misalignment of connecting shafts, lube leakage, excessive heating, or any unusual noise or vibration.
- Serious personal injury may occur as a result of improperly performed maintenance, adjustments or repairs.
- Do not attempt any of the maintenance, checks or repairs described on the following pages if you are not fully familiar with these or other procedures with respect to the transmission, or are uncertain as to how to proceed. Have the necessary work done by a properly equipped and qualified workshop.
- Always be extremely careful when working on the transmission. Always follow commonly accepted safety practices and general common sense. Never risk personal injury.

⚠ CAUTION • Do not operate the transmission or ring and pinion without proper lube and correct amount.

- For safe operation and to maintain the unit warranty, when changing a factory installed fastener for any reason, it becomes the responsibility of the person making the change to properly account for fastener grade, thread engagement, load, tightening torque and the means of torque retention.
- Mounting bolts should be periodically checked to ensure that the unit is firmly anchored for proper operation.
- These instructions are not intended to cover all details or variations in equipment, nor provide for every possible contingency to be met in connection with selection, installation, operation, and maintenance. Should further information be desired or should particular problems arise which are not covered sufficiently for the Buyer's purpose, the matter should be referred to Richmond Gear.

In the event of the resale of any of the goods, in whatever form, Resellers/Buyers will include the following language in a conspicuous place and in a conspicuous manner in a written agreement covering such sale:

The manufacturer makes no warranties or representations, express or implied, by operation of law or otherwise, as to the merchantability or fitness for a particular purpose of the goods sold hereunder. Buyer acknowledges that it alone has determined that the goods purchased hereunder will suitably meet the requirements of their intended use. In no event will the manufacturer be liable for consequential, incidental or other damages. Even if the repair or replacement remedy shall be deemed to have failed of its essential purpose under Section 2-719 of the Uniform Commercial Code, the manufacturer shall have no liability to Buyer for consequential damages.

Resellers/Buyers agree to also include this entire document including the danger, warnings and cautions above in a conspicuous place and in a conspicuous manner in writing to instruct users on the safe usage of the product.

This information should be read together with all other printed information supplied by Richmond Gear.

8221022A

POWERTRAX[®]

Chicago, Il.